

Data Sheet



Article number: 390215006454510

Description: Worm gear
VF 150-FC2-64-112B5, without lubrication

Measures

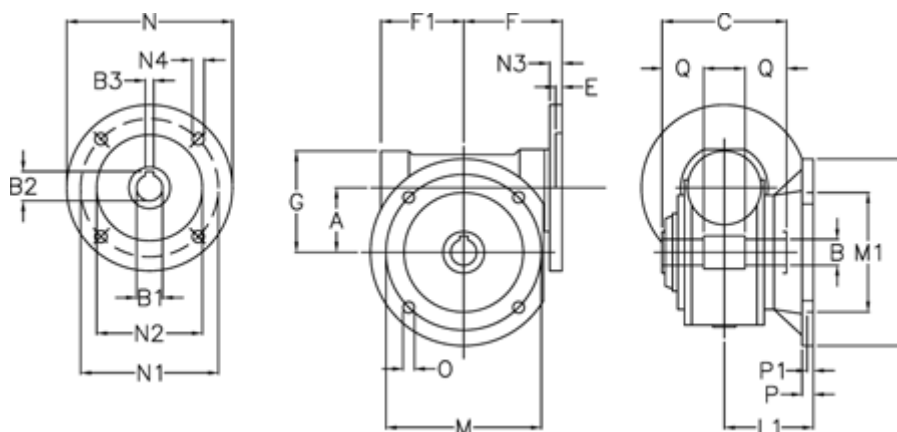

A	= 150	F1	= 179	N2	= 180
B	= 50 H7	G	= 218	N3	= 11
B1	E7 = 28	L	= 350	N4	= 13
B2	= 31.3	L1	= 145.5	O	= 18
B3	H9 = 8	M	= 290	P	= 22
C	= 175	M1	= 200	P1	= 13
E	= 2	N	= 250	Q	= 55
F	= 190	N1	= 215		